



Follow us on Facebook



Catalogue M.108 E



Cutting



Drilling



Grinding



Milling

Grinding tools for...

angle grinders two-hand floor grinder wet grinder multi-disc grinder

atlas gmbh
diamant
QUALITÄT VOM HERSTELLER
Manufaktur

flexibility. **swiftness.** **service.**



Diamond tools from the manufacturer. That's what **atlas** diamant GmbH stands for.

We manufacture in our factory in Wunsiedel in the Fichtelgebirge in Bavaria with finely tuned recipes, future-oriented production processes and with great care and attention to detail.

The clear goal: **long-term partnerships** with satisfied customers

innovation. quality. future.



Step 1

page 06 - 12



removal and
decoat



Step 2

page 13 - 18



grind and
prepare



Step 3

page 19 - 26



fine grinding and
small grain grinding



Step 4

see catalogue SELECTION



polish and
finishing

in **4** steps to the perfect floor





removal and decoat

STEP 1

P. 06

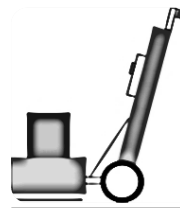
application matrix	DUO PCD	RIPPER PCD	TRIPLEX PCD	3er-STAB PLUS PCD	RANDFIX PCD
	page 08	page 09	page 10	page 11	page 12
adhesive residue, hard	Life	Speed	Speed	Speed	
adhesive residue, soft	Life	Speed	Life	Speed	Special
asbestos					
asphalt	Life	Speed	Speed	Speed	
Coatings <small>(exact information on the respective page)</small>	Life	Speed	Life	Speed	Special
concrete					
hard-grain flooring					
leveling compounds					
mastic asphalt	Life	Speed	Speed	Speed	
old concrete					
paints		Speed	Life		Special
plaster					
power-floated, smoothed					
Sealings		Speed			
Epoxy	Life				
MMA		Speed	Speed		
polyurethane coating		Speed	Life		
OS 11			Speed		
OS 8	Life				

	Item no.	Ø in mm	hole	type
	716-0 115-M14-DUO-SH-right			
	716-0 125 -022-DUO-right			
	716-0 130 -025-DUO-right			
	716-0 150 -019-DUO-right			
	716-0 180 -022-DUO-right			
	716-0 250 -6+6-DUO-right			
	716-0 250 -6+6-DUO-left			
	746-4-DUO-right			
	746-4-DUO-left			

grinding wings available for following machines with surcharge :
Airtec, Blastrac, Contec, Lavina, HTC, Husqvarna, Schwamborn, Scanmaskin
and others.



right = clockwise rotation as viewed from above
= left-turning as viewed from below



Use for ...	
adhesive residue, hard	ok
adhesive residue, soft	ok
asbestos	
asphalt	ok
Coatings e.g. OS 8, Epoxy,	ok
concrete	
hard-grain flooring	
leveling compounds	
mastic asphalt	ok
old concrete paints	
plaster	
power-floated, smoothed	
screed	
sealings	
terrazzo	
tiles, ceramics	
tiles, natural stone	





item no.

Ø in mm

hole

type

729-0125-022-Ripper-right
729-0130-025-Ripper-right
729-0180-022-Ripper-right

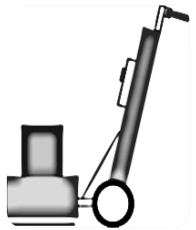
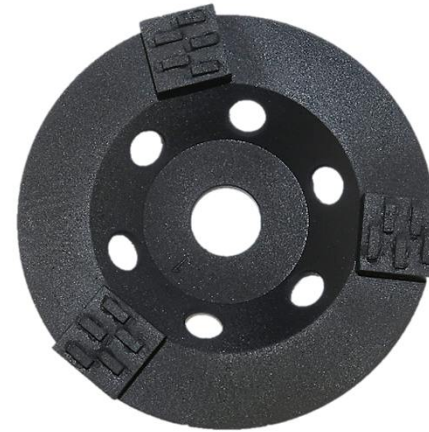

729-0250-019-Ripper-right

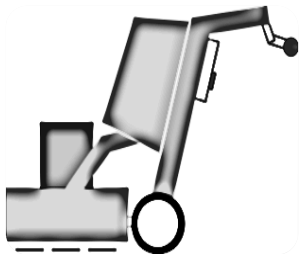

759-1+1-Ripper-right



grinding wings available for following machines with surcharge:
Airtec, Blastrac, Contec, Lavina, HTC, Husqvarna, Schwamborn, Skanmaskin u.a.



right = clockwise rotation as viewed from above
= left-turning as viewed from below

Use for ...

adhesive residue, hard **ok**
adhesive residue, soft **ok**

asbestos
asphalt

coatings
e. g. polyurethane
coating, MMA **ok**

concrete
hard-grain flooring

leveling compounds **ok**
mastic asphalt

old concrete
paints **ok**

plaster
power-floated, smoothed

screed
sealings **ok**

terazzo
tiles, ceramics

tiles, natural stone
filler **ok**

floor surface
hard – flexible/ non-mineral

segment bond
PCD

resulting grinding image
very coarse – coarse

RIPPER

P. 09



item no.	Ø in mm	hole	type
715-0 115-M14-Triplex			
715-0 125 -022-Triplex			
715-0 180 -022-Triplex			



715-0250-12+6-Triplex-left
715-0250-12+6-Triplex-right

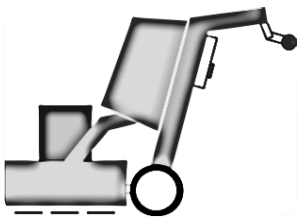

745-3+1-Triplex-left



grinding wings available for following machines with surcharge :
Airtec, Blastrac, Contec, Lavina, HTC, Husqvarna, Schwamborn, Skanmaskin
and others.

Use for ...

adhesive residue, hard	ok
adhesive residue, soft	ok
asbestos	
asphalt	ok
coatings e. g. OS 11, MMA, polyurethane coating	ok
concrete	
hard-grain flooring	
leveling compounds	
mastic asphalt	ok
old concrete	
paints	ok
plaster	
power-floated, smoothed	
screed	
sealings	
terrazzo	
tiles, ceramics	
tiles, natural stone	

floor surface
hard – flexible

segment bond
PCD

resulting grinding image
coarse



TRIPLEX PCD



item no.

Ø in mm

type

729-0 250-6+6-PKD-3er-Stab-plus-left
729-0 250-6+6-PKD-3er-Stab-plus-right

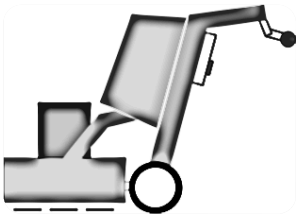

759-1+1-PKD-3er-Stab-plus-left
759-1+1-PKD-3er-Stab-plus-right



grinding wings available for following machines with surcharge :
Airtec, Blastrac, Contec, Lavina, HTC, Husqvarna, Schwamborn,
Scanmaskin and others.
Only for floor machines!



right = clockwise rotation as viewed from above
= left-turning as viewed from below

**Very robust
and durable!**



Use for ...

adhesive residue, hard **ok**
adhesive residue, soft **ok**

asbestos
asphalt **ok**

coatings **ok**
e. g. polyurethane
coating, MMA

concrete
hard-grain flooring

leveling compounds
mastic asphalt **ok**

old concrete
paints

plaster
power-floated, smoothed

screed
sealings

terazzo
tiles, ceramics

tiles, natural stone
filler **ok**

Note:
PCD protrudes approx. 2 mm over
the edge of the grinding cup



item no.	Ø in mm	hole	type
717-0 125 -022-RandFIX-right			
717-0 180 -022-RandFIX-right			

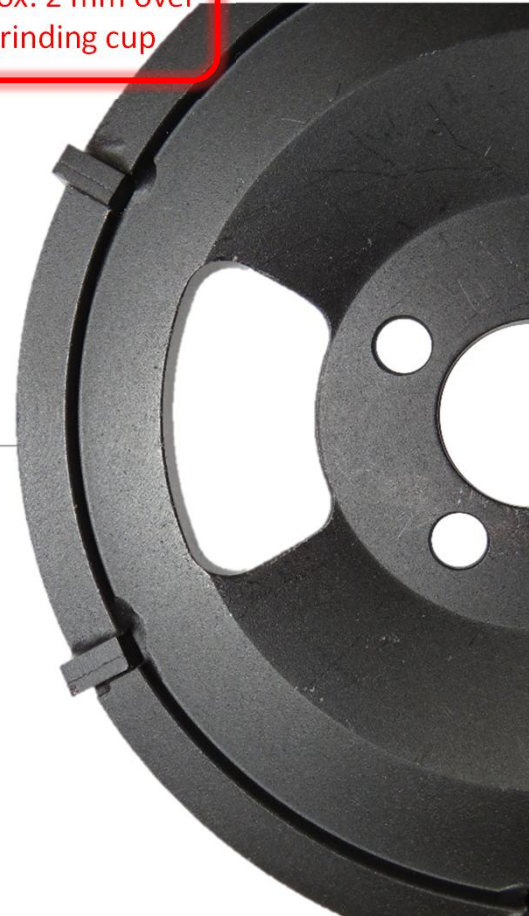

Use for ...

adhesive residue, hard	
adhesive residue, soft	ok
asbestos	
asphalt	
coatings > 2mm	ok
coatings < 2mm	ok
concrete	
hard-grain flooring	
leveling compounds	
mastic asphalt	
old concrete	
paints	ok
plaster	
power-floated, smoothed	
screed	
sealings	
terrazzo	
tiles, ceramics	
tiles, natural stone	





grind and prepare

STEP 2

P. 13



application matrix	RONDO PCD	RONDO ULTRA PCD	WAVE PCD	COOL RUNNER PCD
	page 15	page 16	page 17	page 18
adhesive residue, hard	Life	Speed	Speed	Life
adhesive residue, soft		Speed	Speed	Life
asbestos	Life	Speed	Speed	Life
asphalt	Life	Speed	Speed	Life
coatings > 2mm			Speed	
coatings < 2mm	Life	Speed	Speed	Life
concrete	Life	Speed	Speed	Life
hard-grain flooring	Life	Speed	Speed	Life
leveling compounds		Speed	Speed	Life
mastic asphalt	Life	Speed	Speed	Life
old concrete	Life	Speed	Speed	Life
paints	Life	Speed	Speed	Life
plaster	Life	Speed	Speed	Life
power-floated, smoothed		Speed	Speed	Life
screed	Life	Speed	Speed	Life
sealings	Life	Speed	Speed	Life
terazzo				
tiles, ceramics		Speed	Speed	Life

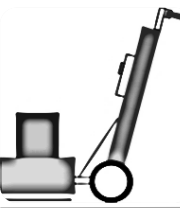
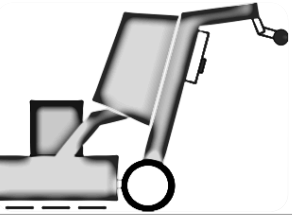

tiles, natural stone

	item no.	Ø in mm	hole	type
	702-0 115-M14-Rondo-H			
	702-0 125 -022-Rondo-H			
	702-0 130 -025-Rondo-H			
	702-0 150 -019-Rondo-H			
	702-0 180 -022-Rondo-H			
	702-0 250 -12S-Rondo-H			
	732-2-Rondo-H			

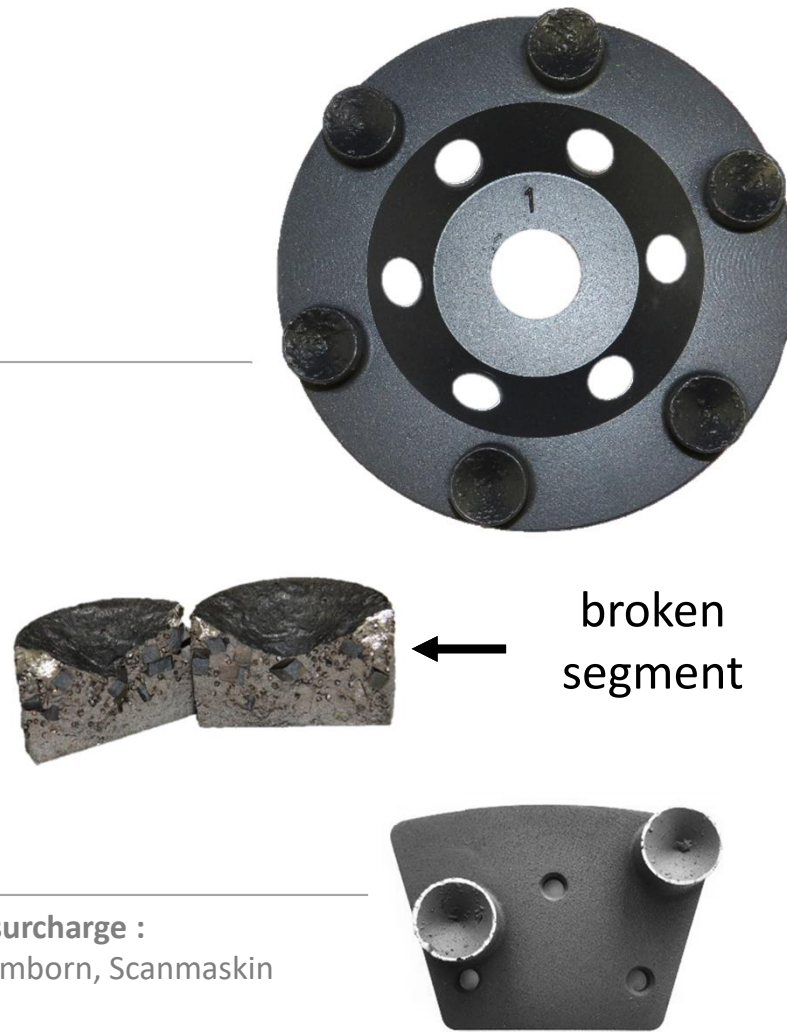
grinding wings available for following machines with surcharge :
Airtec, Blastrac, Contec, Lavina, HTC, Husqvarna, Schwamborn, Scanmaskin and others.

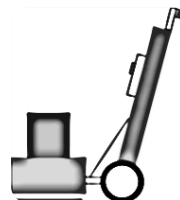

Use for ...	
adhesive residue, hard	ok
adhesive residue, soft	ok
asbestos	ok
asphalt	ok
coatings > 2mm	
coatings < 2mm	ok
concrete	ok
hard-grain flooring	ok
leveling compounds	
mastic asphalt	ok
old concrete	ok
paints	ok
plaster	ok
power-floated, smoothed	
screed	ok
sealings	ok
terrazzo	
tiles, ceramics	
tiles, natural stone	

	item no.	Ø in mm	hole	type
	709-0 115-M14-Rondo-u-AGM			
	709-0 125 -022-Rondo-u-AGM			
	709-0 130 -025-Rondo-u-AGM			
	709-0 150 -019-Rondo-u-AGM			
	709-0 180 -022-Rondo-u-AGM			
	709-0 250 -12S-Rondo-u-AGM			
	739-2-Rondo-u-AGM			

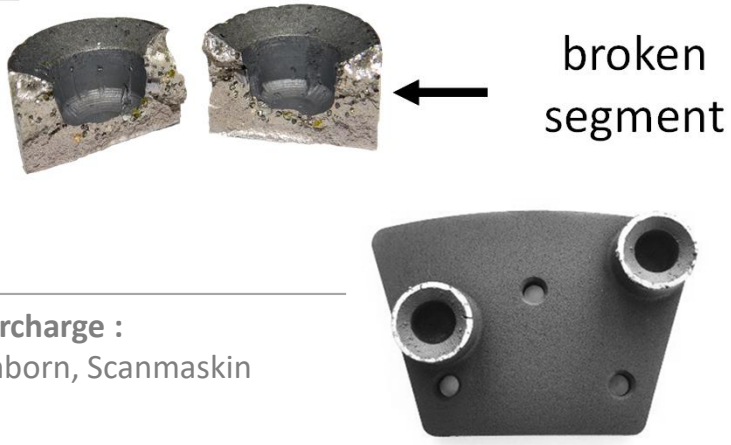

grinding wings available for following machines with surcharge :
Airtec, Blastrac, Contec, Lavina, HTC, Husqvarna, Schwamborn, Scanmaskin and others.

Use for ...	
adhesive residue, hard	ok
adhesive residue, soft	ok
asbestos	ok
asphalt	ok
coatings > 2mm	
coatings < 2mm	ok
concrete	ok
hard-grain flooring	ok
leveling compounds	ok
mastic asphalt	ok
old concrete	ok
paints	ok
plaster	ok
power-floated, smoothed	ok
screed	ok
sealings	ok
terrazzo	
tiles, ceramics	ok
tiles, natural stone	

floor surface
very hard – hard

segment bond
medium – hard

resulting grinding image
coarse – medium





item no.	Ø in mm	hole	type
724-0 115-M14-Wave-PKD			
724-0 125 -022-Wave-PCD			
724-0 130 -025-Wave-PCD			
724-0 150 -019-Wave-PCD			
724-0 180 -022-Wave-PCD			

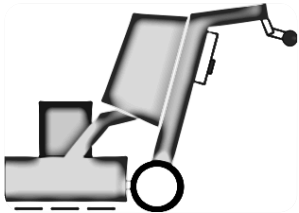

754-6-Wave-PCD



← broken segment



Use for ...

adhesive residue, hard	ok
adhesive residue, soft	ok
asbestos	ok
asphalt	ok
coatings > 2mm	ok
coatings < 2mm	ok
concrete	ok
hard-grain flooring	ok
leveling compounds	ok
mastic asphalt	ok
old concrete	ok
paints	ok
plaster	ok
power-floated, smoothed	ok
screed	ok
sealings	ok
terrazzo	ok
tiles, ceramics	ok
tiles, natural stone	

grinding wings available for following machines with surcharge :
Airtec, Blastrac, Contec, Lavina, HTC, Husqvarna, Schwamborn, Scanmaskin and others.



floor surface
very hard – hard

segment bond
medium – hard

resulting grinding image
coarse – medium

WAVE PCD

P. 17

	item no.	Ø in mm	hole	type
	713-0 115-M14-Cool-Runner			
	713-0 125 -022-Cool-Runner			
	713-0 130 -025-Cool-Runner			
	713-0 150 -019-Cool-Runner			
	713-0 180 -022-Cool-Runner			
	713-0 250 -12S-Cool-Runner			
	743-2-Cool-Runner			



broken segment

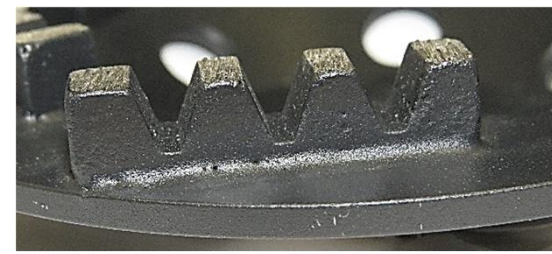
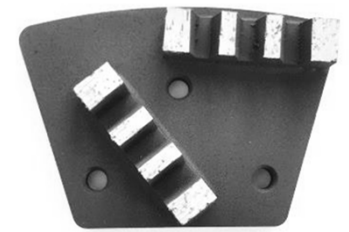

Use for ...	
adhesive residue, hard	ok
adhesive residue, soft	ok
asbestos	ok
asphalt	ok
coatings > 2mm	ok
coatings < 2mm	ok
concrete	ok
hard-grain flooring	ok
leveling compounds	ok
mastic asphalt	ok
old concrete	ok
paints	ok
plaster	ok
power-floated, smoothed	ok
screed	ok
sealings	ok
terrazzo	ok
tiles, ceramics	ok
tiles, natural stone	

grinding wings available for following machines with surcharge :
Airtec, Blastrac, Contec, Lavina, HTC, Husqvarna, Schwamborn, Scanmaskin and others.

floor surface
very hard – soft

segment bond
medium – hard

resulting grinding image
coarse – medium



fine grinding and small grain grinding



STEP 3

P. 19



application matrix	ADESSO DIA	TONDO DIA	TONDO ULTRA DIA	TONDO GRANDE	RHOMBUS DIA	RHOMBUS V DIA
	page 21	page 22	page 23	page 24	page 25	page 26
adhesive residue, hard adhesive residue, soft			Speed		Life	Speed
asbestos						
asphalt		Speed			Life	Speed
coatings > 2mm coatings < 2mm						
concrete	Life	Speed	Speed	Speed	Life	Speed
hard-grain flooring	Life				Speed	Speed
leveling compounds		Speed	Speed		Life	Speed
mastic asphalt		Speed			Life	Speed
old concrete	Life	Speed	Speed	Speed	Life	Speed
paints		Speed			Life	Speed
plaster						
power-floated, smoothed		Speed	Speed	Speed	Life	Speed
screed	Life			Speed	Speed	Speed
sealings		Speed			Life	Speed
terrazzo	Life			Speed	Speed	Speed
tiles, ceramics						
tiles, natural stone						

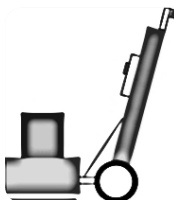

	item no.	Ø in mm	hole	type	available bonds
	720-0 125 -022-Adesso				<input checked="" type="checkbox"/> <input checked="" type="checkbox"/> <input type="checkbox"/>
	720-0 130 -025-Adesso				<input checked="" type="checkbox"/> <input checked="" type="checkbox"/> <input type="checkbox"/>
	720-0 150 -019-Adesso				<input checked="" type="checkbox"/> <input checked="" type="checkbox"/> <input type="checkbox"/>
	720-0 180 -022-Adesso				<input checked="" type="checkbox"/> <input checked="" type="checkbox"/> <input type="checkbox"/>
	720-0 250 -12S-Adesso				<input checked="" type="checkbox"/> <input checked="" type="checkbox"/> <input type="checkbox"/>
	750-2-Adesso				<input checked="" type="checkbox"/> <input checked="" type="checkbox"/> <input type="checkbox"/>

soft
medium
hard



grinding wings available for following machines with surcharge :
Airtec, Blastrac, Contec, Lavina, HTC, Husqvarna, Schwamborn, Scanmaskin
and others.

Use for ...



adhesive residue, hard	
adhesive residue, soft	
asbestos	
asphalt	
coatings > 2mm	
coatings < 2mm	
concrete	ok
hard-grain flooring	ok
leveling compounds	
mastic asphalt	
old concrete	ok
paints	
plaster	
power-floated, smoothed	
screed	ok
sealings	
terrazzo	ok
tiles, ceramics	
tiles, natural stone	

available grains : #14/18 #30/40 #60/80 #100/120 #140/200

floor surface
hard – medium – soft

segment bond
soft – medium – hard

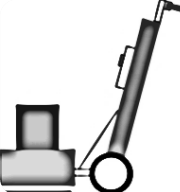
resulting grinding image
coarse – very fine

	item no.	Ø in mm	hole	type	available bonds
	710-0 115-M14-Tondo				<input type="checkbox"/> soft <input type="checkbox"/> medium <input type="checkbox"/> hard
	710-0 125 -022-Tondo				<input type="checkbox"/> soft <input type="checkbox"/> medium <input type="checkbox"/> hard
	710-0 130 -025-Tondo				<input type="checkbox"/> soft <input type="checkbox"/> medium <input type="checkbox"/> hard
	710-0 150 -019-Tondo				<input type="checkbox"/> soft <input type="checkbox"/> medium <input type="checkbox"/> hard
	710-0 180 -022-Tondo				<input type="checkbox"/> soft <input type="checkbox"/> medium <input type="checkbox"/> hard
	710-0 250 -12S-Tondo				<input type="checkbox"/> soft <input type="checkbox"/> medium <input type="checkbox"/> hard
	740-2-Tondo				<input type="checkbox"/> soft <input type="checkbox"/> medium <input type="checkbox"/> hard





Use for ...	
adhesive residue, hard	ok
adhesive residue, soft	
asbestos	
asphalt	
coatings > 2mm	
coatings < 2mm	
concrete	ok
hard-grain flooring	
leveling compounds	ok
mastic asphalt	
old concrete	ok
paints	
plaster	
power-floated, smoothed	ok
screed	
sealings	
terrazzo	
tiles, ceramics	
tiles, natural stone	

grinding wings available for following machines with surcharge :
Airtec, Blastrac, Contec, Lavina, HTC, Husqvarna, Schwamborn, Scanmaskin and others.

available grains : #30/40 #60/80 #100/120 #140/200

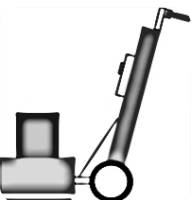
floor surface hard – medium – soft	segment bond soft – medium – hard	resulting grinding image medium – fine
---------------------------------------	--------------------------------------	---

	item no.	Ø in mm	hole	type	available bonds
	701-0 115-M14-Tondo-Ultra				<input type="checkbox"/> <input type="checkbox"/> <input type="checkbox"/>
	701-0 125 -022-Tondo-Ultra				<input type="checkbox"/> <input type="checkbox"/> <input type="checkbox"/>
	701-0 130 -025-Tondo-Ultra				<input type="checkbox"/> <input type="checkbox"/> <input type="checkbox"/>
	701-0 150 -019-Tondo-Ultra				<input type="checkbox"/> <input type="checkbox"/> <input type="checkbox"/>
	701-0 180 -022-Tondo-Ultra				<input type="checkbox"/> <input type="checkbox"/> <input type="checkbox"/>
	701-0 250 -12S-Tondo-Ultra				<input type="checkbox"/> <input type="checkbox"/> <input type="checkbox"/>
	731-2-Tondo-Ultra				<input type="checkbox"/> <input type="checkbox"/> <input type="checkbox"/>

soft
medium
hard



grinding wings available for following machines with surcharge :
Airtec, Blastrac, Contec, Lavina, HTC, Husqvarna, Schwamborn, Scanmaskin and others.

Use for ...

adhesive residue, hard	ok
adhesive residue, soft	
asbestos	
asphalt	ok
coatings > 2mm	
coatings < 2mm	
concrete	ok
hard-grain flooring	
leveling compounds	ok
mastic asphalt	ok
old concrete	ok
paints	ok
plaster	
power-floated, smoothed	ok
screed	
sealings	ok
terrazzo	ok
tiles, ceramics	
tiles, natural stone	

available grains : #30/40 #60/80 #100/120

floor surface
hard – medium – soft

segment bond
soft – medium – hard

resulting grinding image
medium – fine

XXL-Segment!

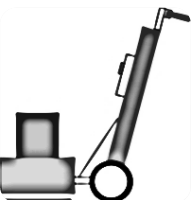
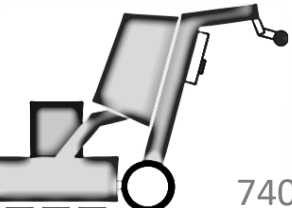
item no.	Ø in mm	hole	type	available bonds
	710-0125-022-m-K0-Tondo-Grande			<input type="checkbox"/> <input type="checkbox"/> <input type="checkbox"/>
	710-0130-025-m-K0-Tondo-Grande			<input type="checkbox"/> <input type="checkbox"/> <input type="checkbox"/>
	710-0180-022-m-K0-Tondo-Grande			<input type="checkbox"/> <input type="checkbox"/> <input type="checkbox"/>
	710-0250-6S-m-K0-Tondo-Grande			<input type="checkbox"/> <input type="checkbox"/> <input type="checkbox"/>
				soft medium hard
	740-1-m-K0-Tondo-Grande			<input type="checkbox"/> <input type="checkbox"/> <input type="checkbox"/>

grinding wings available for following machines with surcharge :
Airtec, Blastrac, Contec, Lavina, HTC, Husqvarna, Schwamborn, Scanmaskin and others.

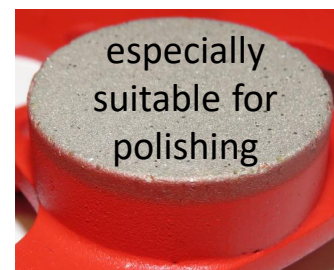

Ø30 mm

Use for ...	
adhesive residue, hard	<input type="checkbox"/>
adhesive residue, soft	<input type="checkbox"/>
asbestos	<input type="checkbox"/>
asphalt	<input type="checkbox"/>
coatings > 2mm	<input type="checkbox"/>
coatings < 2mm	<input type="checkbox"/>
concrete	<input checked="" type="checkbox"/>
hard-grain flooring	<input type="checkbox"/>
leveling compounds	<input type="checkbox"/>
mastic asphalt	<input type="checkbox"/>
old concrete	<input checked="" type="checkbox"/>
paints	<input type="checkbox"/>
plaster	<input type="checkbox"/>
power-floated, smoothed	<input checked="" type="checkbox"/>
screed	<input checked="" type="checkbox"/>
sealings	<input type="checkbox"/>
terrazzo	<input checked="" type="checkbox"/>
tiles, ceramics	<input type="checkbox"/>
tiles, natural stone	<input type="checkbox"/>

available grains : #14/18 #30/40 #60/80 #100/120 #140/200

floor surface
hard – medium – soft

segment bond
soft – medium – hard

resulting grinding image
medium – fine

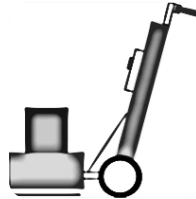
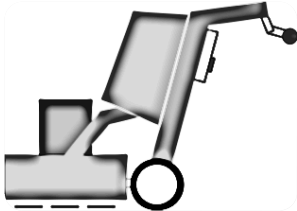
	item no.	Ø in mm	hole	type	available bonds
	711-0 115-M14-Rhombus				<input type="checkbox"/> <input type="checkbox"/> <input type="checkbox"/>
	711-0 125 -022-Rhombus				<input type="checkbox"/> <input type="checkbox"/> <input type="checkbox"/>
	711-0 130 -025-Rhombus				<input type="checkbox"/> <input type="checkbox"/> <input type="checkbox"/>
	711-0 150 -019-Rhombus				<input type="checkbox"/> <input type="checkbox"/> <input type="checkbox"/>
	711-0 180 -022-Rhombus				<input type="checkbox"/> <input type="checkbox"/> <input type="checkbox"/>
	711-0 250 -12S-Rhombus				<input type="checkbox"/> <input type="checkbox"/> <input type="checkbox"/>
	741-2-Rhombus				<input type="checkbox"/> <input type="checkbox"/> <input type="checkbox"/>

soft
medium
hard

grinding wings available for following machines with surcharge :
Airtec, Blastrac, Contec, Lavina, HTC, Husqvarna, Schwamborn, Scanmaskin and others.





Use for ...	
adhesive residue, hard	ok
adhesive residue, soft	
asbestos	
asphalt	ok
coatings > 2mm	
coatings < 2mm	
concrete	ok
hard-grain flooring	ok
leveling compounds	ok
mastic asphalt	ok
old concrete	ok
paints	ok
plaster	
power-floated, smoothed	ok
screed	ok
sealings	ok
terrazzo	ok
tiles, ceramics	
tiles, natural stone	

available grains : #14/18 #30/40 #60/80 #100/120 #140/200

floor surface
hard – medium – soft

segment bond
soft – medium – hard

resulting grinding image
coarse – very fine

	item no.	Ø in mm	hole	type	available bonds
	708-0 115- M14-Rhombus-V				<input type="checkbox"/> <input type="checkbox"/> <input type="checkbox"/>
	708-0 125 -022-Rhombus-V				<input type="checkbox"/> <input type="checkbox"/> <input type="checkbox"/>
	708-0 130 -025-Rhombus-V				<input type="checkbox"/> <input type="checkbox"/> <input type="checkbox"/>
	708-0 150 -019-Rhombus-V				<input type="checkbox"/> <input type="checkbox"/> <input type="checkbox"/>
	708-0 180 -022-Rhombus-V				<input type="checkbox"/> <input type="checkbox"/> <input type="checkbox"/>
	708-0 250 -12S-Rhombus-V				<input type="checkbox"/> <input type="checkbox"/> <input type="checkbox"/>
	742-2-Rhombus-V				<input type="checkbox"/> <input type="checkbox"/> <input type="checkbox"/>

soft
medium
hard

grinding wings available for following machines with surcharge :
Airtec, Blastrac, Contec, Lavina, HTC, Husqvarna, Schwamborn, Scanmaskin and others.



Use for ...	
adhesive residue, hard	ok
adhesive residue, soft	
asbestos	
asphalt	ok
coatings > 2mm	
coatings < 2mm	
concrete	ok
hard-grain flooring	ok
leveling compounds	ok
mastic asphalt	ok
old concrete	ok
paints	ok
plaster	
power-floated, smoothed	ok
screed	ok
sealings	ok
terrazzo	ok
tiles, ceramics	
tiles, natural stone	

available grains : #14/18 #30/40 #60/80 #100/120 #140/200

floor surface hard – medium – soft
segment bond soft – medium – hard
resulting grinding image coarse – very fine



atlas Individual

Create your own diamond-tool

You would like a tool specially tailored to your application, according to your ideas please contact us



Special wishes can be realized in the **atlas** *Manufactory*...

atlas Individual

Create your own diamond-tool

SELF
MADE

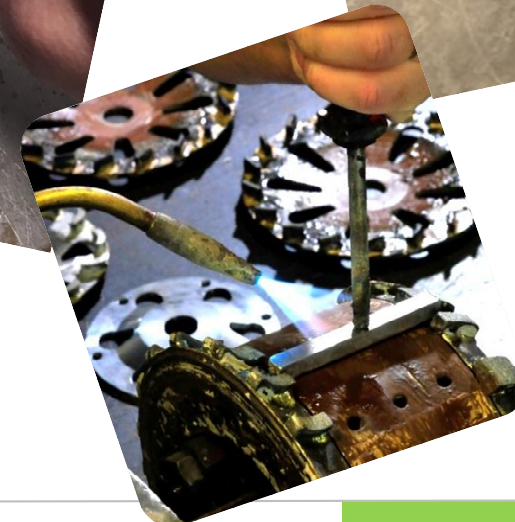
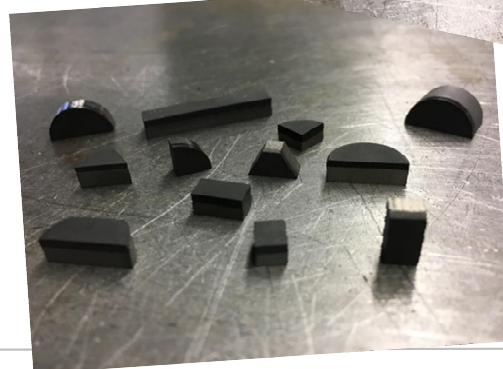
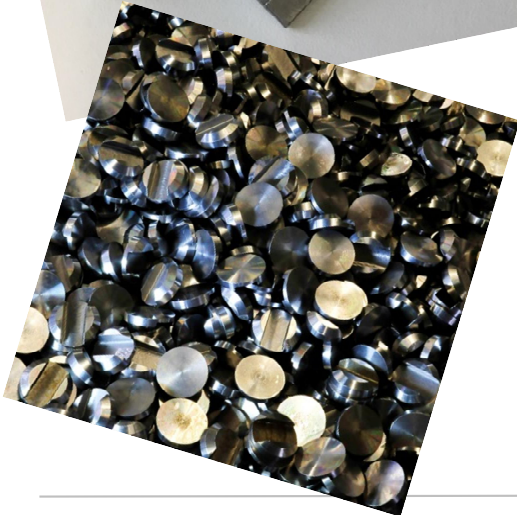
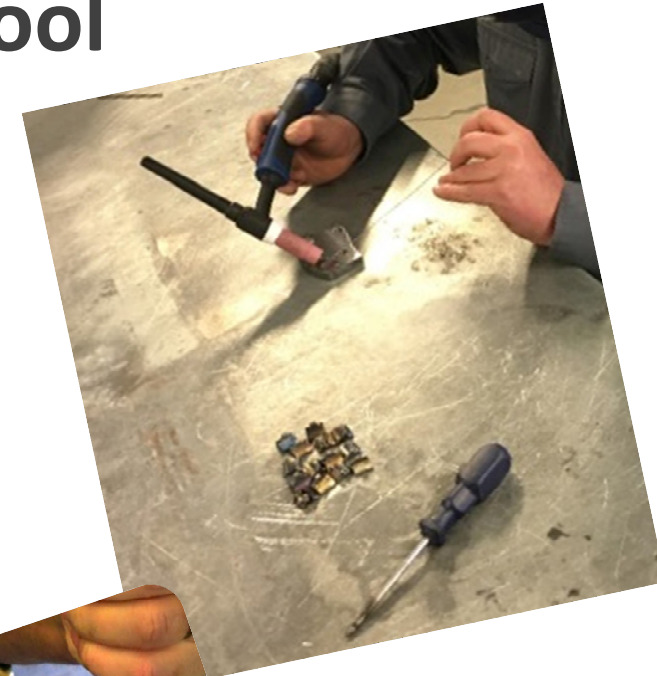
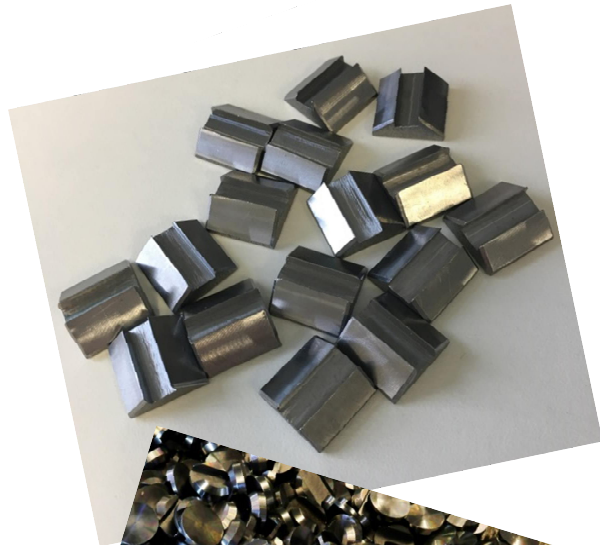

Special wishes can be realized in the **atlas** *Manufaktur* ...

Vorlagen zum Ausdrucken

General terms of sale and delivery of atlas diamant GmbH, 95632 Wunsiedel

\$ 1 General – Scope

- 1.1 All our deliveries are subject to the following conditions, unless otherwise agreed in writing.
- 1.2 The following terms of delivery apply to all contracts, deliveries and other services, unless they are changed or excluded with the express consent of the seller. Different conditions of the buyer, which the seller does not expressly recognize in writing, are non-binding, even if the seller does not expressly object.
- 1.3 Orders become binding only after our written confirmation.
- 1.4 Our terms and conditions also apply to all future business with the customer.

\$ 2 Offer and delivery conditions

- 2.1 Our offers are non-binding. The conclusion is made by our written order confirmation. Collateral agreements are only effective if they have been confirmed by us in writing. Once placed orders are irrevocable and non-cancellable. The buyer is liable for the correctness of the documents to be delivered by him, in particular drawings, gauges and samples.
- 2.2 The prices are ex works, they are non-binding. We reserve the right to adjust the prices if there is a change in the cost factors in the period between submission of the offer and delivery.
- 2.3 Added to the prices is the value added tax in the respective statutory amount.
- 2.4 For the delivery of the goods, the buyer is obliged to provide the necessary packaging and to ensure that the goods are protected against damage during transport.
- 2.5 The minimum order value is 50,00 €, otherwise a minimum quantity surcharge will be charged. Exempted from this are repair parts, however, plus transport costs.
- 2.6 Unless otherwise agreed in writing, delivery is ex works Wunsiedel.
- 2.7 We are entitled to make partial deliveries.
- 2.8 Information on the delivery time or the delivery date are to be understood as guideline values that can be exceeded or fallen below, this applies in particular in the event of faults occurring outside our control.
- 2.9 Delivery times may be extended or shortened. The buyer shall be notified by the customer, even if change of delivery has been agreed.
- 2.10 We are not liable for any loss or damage.
- 2.11 The buyer must check the delivered goods immediately upon receipt. Any damage to the goods, including the packaging, must be noted on the bill of lading and acknowledged by the driver. Later reported damages are not recognized by the forwarding insurance and are therefore at the expense of the buyer.

\$ 3 Terms of payment

- 3.1 Our invoices are payable within 10 days with 2% discount or within 30 days net, unless otherwise agreed in writing. Repair and spare parts invoices are due immediately net.
- 3.2 Conditions for repairs will be changed if the repair is not to be carried out.
- 3.3 If the buyer is in default of payment of an invoice, all liabilities to us are immediately due.
- 3.4 Checks are accepted only on account of performance and are only valid after unconditional credit as payment. Bank fees are charged to the buyer.
- 3.5 The statutory rules regarding the consequences of late payments apply.
- 3.6 If the buyer is in default of payment, we reserve the right to suspend the supply of goods.
- 3.7 Initial orders with new customers are processed against advance payment.

\$ 4 Warranty

- 4.1 For the quality of the products supplied by us warranty is accepted for manufacturing or material defects due to repair or replacement occurring within the statutory or contractual deadline. Otherwise, we guarantee the products for a period of 12 months from the date of purchase. The warranty is not extended by the fact that the goods are repaired or replaced. The guarantee period for the goods is 12 months from the date of purchase. The warranty is not extended by the fact that the goods are repaired or replaced. The warranty is not extended by the fact that the goods are repaired or replaced. The warranty is not extended by the fact that the goods are repaired or replaced.
- 4.2 In the event of a complaint of material defects, representative samples of the goods complained about must be sent to us for evaluation. Notifications of defects can only be processed by us if at least 50% of the original diamond coating is still present.
- 4.3 According to § 377 HGB, the buyer must duly fulfil his examination and complain's obligations. Complaints due to obvious or hidden defects must be made immediately after receipt of the goods. In the case of justified notice of defects, we are entitled to the right to repair or replacement. We are not liable for damages that are not incurred on the goods themselves, and not for lost profits or other financial losses of the buyer.
- 4.4 Warranty is excluded for goods which have become unusable due to improper use, which has been altered, which is worn or worn due to operational conditions.
- 4.5 Complaints can only be accepted in conjunction with a proof of purchase (invoice copy).

\$ 5 Guarantee

- 5.1 As a result of deliveries by us, we guarantee for a period of 12 months from the date of purchase. We undertake to repair the products gratuitously, if delivered free of charge to us if they have become defective as a product of material or manufacturing defects. A condition for the guarantee obligation is that the products were treated properly. Parts that are subject to natural wear are not covered by warranty. The warranty is void in case of damage due to improper operation and improper use. Incorrect installation, intervention by unauthorized persons or use of accessories or spare parts that are not original parts.
- 5.2 Return of warranty cases and repairs must be agreed in advance with us, the resulting transport and packaging costs are always at the expense of the buyer, this applies in particular to damage to the goods due to improper transport packaging. For returns due to incorrect orders by the buyer 20% of the value of the goods, as well as incurred transport and packaging costs are charged to the buyer. The goods will be taken back only after explicit approval by us. The goods must be in perfect condition. For special orders, as well as for custom made, no return option.
- 5.3 Further obligations, such as damage claims e.g. liability for property damage and personal injury, compensation for lost time or other financial loss are also excluded.

\$ 6 EAN bar code (GTIN – Global Trade Item Number)

- 6.1 The buyer is obliged to verify the correctness of the EAN bar code attached to the goods or any other code attached to the goods upon reception of the goods immediately by random checks. Our liability for incorrect coding is limited.

\$ 7 Retention of title

- 7.1 We reserve title to the purchased item until receipt of all payments from the business relationship with the customer. In case of breach of contract by the customer, in particular in case of default, we are entitled to reclaim the goods. The withdrawal of the purchased item by us is a withdrawal from the contract. After the return of the purchased goods, we are entitled to their recovery, the proceeds of the sale shall be credited against the customer's debts, less reasonable exploitation costs.
- 7.2 The dealer customer is obliged to handle the purchased goods with care, in particular, he is obliged to insure these at his own expense against damage caused by fire, water and theft to the value of new. If maintenance and inspection work is required, the customer must carry it out on time at their own expense.
- 7.3 In the event of seizure or other interference by third parties, the customer must notify us immediately in writing, so that we can file an action in accordance with § 771 ZPO. Insofar as the third party is not in a position to release the goods, the customer is obliged to take the necessary measures to release the goods.
- 7.4 The dealer customer is entitled to resell the purchased item in the ordinary course of business; however, it hereby assigns to us all claims in the amount of the final invoice amount (including VAT) of our claim arising from the resale against its customers or third parties, irrespective of whether the purchased goods were resold without or after processing. To collect this claim, the customer remains authorized even after the assignment. Our authority to collect the claim itself remains unaffected. However, we undertake not to collect the claim as long as the customer meets his payment obligations from the proceeds received, does not default on payment and, in particular, has not filed an application for settlement or insolvency proceedings or has ceased payments. However, if this is the case, we can demand that the customer notify us of the assigned claims and their debtors, provide all information necessary for collection, hand over the associated documents and notify the debtors (third parties) of the assignment.
- 7.5 The processing or transformation of the purchased item by the customer is always carried out for us. If the purchased item is processed with other items not belonging to us, we acquire the co-ownership of the new goods or the co-ownership of the purchased item (including VAT) to the other processed items at the time of processing. Incidentally, the same applies to the object resulting from processing if the purchased item is inseparably mixed with other items not belonging to us. We acquire co-ownership of the new item in proportion of the value of the purchased item (final invoice amount, including VAT) to the other mixed items at the time of mixing; if the mixing takes place in such a way that the customer's item is to be regarded as the main item, it shall be deemed agreed that the customer assigns proportional co-ownership to us. The customer keeps the resulting sole ownership or co-ownership for us.

\$ 8 Goods return

- 8.1 We will only take back goods delivered by us with express consent.
- 8.2 The return must be made stating our delivery note or invoice number, otherwise no processing is possible. The return is in any case to be made free. Unfree returned goods we do not accept.
- 8.3 To cover our processing costs, the credit will be reduced by 20% of the value of the goods. Returns that are caused by our fault remain excluded from this.

\$ 9 Place of performance

- 9.1 Place of fulfillment for payment and delivery is our place of business.

\$ 10 Jurisdiction

- 10.1 Place of jurisdiction for merchants is Wunsiedel (95632).

\$ 11 Catalogs

- 11.1 The illustrations of our catalogs and brochures are not binding for the execution. We reserve the right to make changes to the design at any time. For deviations from the specified dimensions, weights, etc., we assume no liability. We are not liable for any typographical errors in our catalogs, brochures, price lists and other publications.

\$ 12 Copyright

- 12.1 We reserve the rights of ownership and copyright to illustrations, drawings, samples or other documents. They may not be made accessible to third parties without our permission and must be returned immediately upon request.

07/2013



Visit us on Facebook!



atlas diamant GmbH

Am Ratskalkofen 7
DE-95632 Wunsiedel

Tel. +49 9232 / 3588

Fax +49 9232 / 7999

info@atlas-diamant.de



Please contact us if you have any further questions!